

# NEOLINEO/EW



E.C. TECHNOLOGY  
WITH BUILT-IN VSD



**In-line duct extractor fans with a detachable body and small size, fitted with an E.C. Technology motor.**



**CONTROL**  
Supplied as an optional accessory

**Fan:**

- Casing made of self-extinguishing V0 plastic material.
- External terminal box with variable position.
- Easy, rapid installation.

**Motor:**

- E.C. Technology motors fitted with long-life ball bearings.
- IP44 protection.
- Two-speed selector switch.
- Each speed can be adjusted by a power meter in the terminal box. Model 315 adjustable using 0-10 V external signal.

- Single-phase 220/-240 V-50 Hz.

- Operating temperature:  
Models 100, 125 and 150: -10 °C +60 °C.  
Models 200, 250 and 315: -10 °C +50 °C.

**Finish:**

- Made of V0 white, plastic, self-extinguishing material.

**Order code**

**NEOLINEO/EW — 100 — (Q)**

NEOLINEO/EW: In-line duct extractor fans with a detachable body and small size, fitted with E.C. Technology motors.

Nozzle diameter in mm

Q reference, low flow rate level

**Technical characteristics**

	Speed regulation	Speed (r/min) min./max.	Current (A) min./max.	Power (W) min./max.	Maximum flow rate (m <sup>3</sup> /h) min./max.	Sound pressure level Lp dB(A)* min./max.	Approx. weight (kg)	According to ErP
NEOLINEO/EW-100-Q	Min. sp.	1420/2120	0.05/0.08	4.5/7	90/145	21/33	1.5	Excluded
	Nom. sp.	2125/2850	0.07/0.12	7/12	155/210	29/40		
	Max. sp.	2560/3300	0.10/0.16	10/16.5	170/230	34/45		
NEOLINEO/EW-100	Min. sp.	1320/1650	0.06/0.09	5.5/8	140/185	25/31	1.9	Excluded
	Nom. sp.	1620/2000	0.09/0.12	8/12	180/255	31/36		
	Max. sp.	1920/2330	0.11/0.17	11/17	220/270	36/41		
NEOLINEO/EW-125	Min. sp.	1285/1660	0.07/0.11	6.5/10.5	190/270	29/35	1.8	Excluded
	Nom. sp.	1600/2040	0.10/0.17	10/17	250/365	35/40		
	Max. sp.	1870/2370	0.13/0.22	13.5/24	300/380	39/44		
NEOLINEO/EW-150	Min. sp.	1340/1895	0.10/0.20	10/22	325/440	35/44	2.2	Excluded
	Nom. sp.	1630/2230	0.15/0.31	15/35	385/550	42/47		
	Max. sp.	1870/2560	0.20/0.44	22/52	465/620	46/53		
NEOLINEO/EW-160	Min. sp.	1300/1900	0.10/0.21	10/23	325/450	34/45	2.1	Excluded
	Nom. sp.	1560/2290	0.15/0.33	15/38	385/570	39/48		
	Max. sp.	1830/2620	0.20/0.45	22/55	465/630	46/54		
NEOLINEO/EW-200	Min. sp.	1990/2330	0.21/0.32	22/34	620/760	39/44	2.5	Excluded
	Nom. sp.	2400/2820	0.33/0.50	36/57	750/1000	45/46		
	Max. sp.	2750/3120	0.47/0.63	53/74	870/1080	45/48		
NEOLINEO/EW-250	Min. sp.	1720/2280	0.26/0.54	27/59	650/850	43/51	5.3	Excluded
	Nom. sp.	2100/2750	0.42/0.83	45/95	800/1150	47/55		
	Max. sp.	2400/3010	0.59/1.06	65/124	920/1250	51/57		
NEOLINEO/EW-315		1800/2350	0.83/1.60	119/240	1400/1900	53/61	9.5	2015

\*Irradiated sound pressure levels obtained at a distance of 3 metres in a free field, with rigid inlet/exhaust tubes.

## Dimensions mm

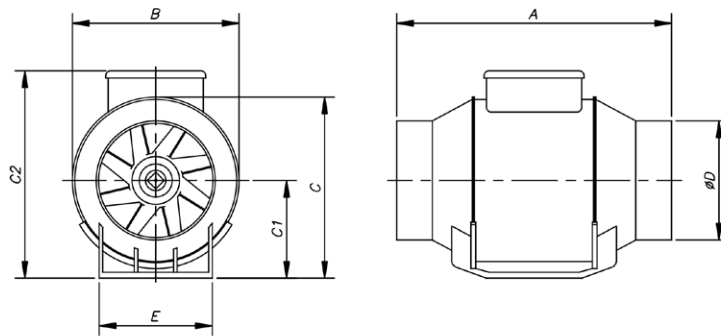

	A	B	C	C1	C2	ØD	E
NEOLINEO/EW-100	303	188.5	240	101.5	189	96	90
NEOLINEO/EW-125	258	188.5	240	101.5	189	122	90
NEOLINEO/EW-150	294	214.5	265	112.5	212	146	110
NEOLINEO/EW-160	272.5	214.5	265	112.5	212	156	110
NEOLINEO/EW-200	300	234.5	290	125.5	235	196	140
NEOLINEO/EW-250	385	300	350	152.5	292	247	176.5



## Erp. Characteristic curves and ErP data

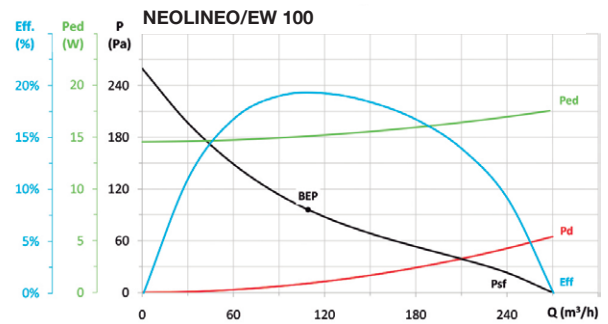

MC	EC	SR	Cc	$\eta_a$ (%)*	N	[kW]	[m³/h]	[Pa]	[rpm]	VSD
A	S	-	-	-	-	0,015	109	96	2330	INTEGRATED

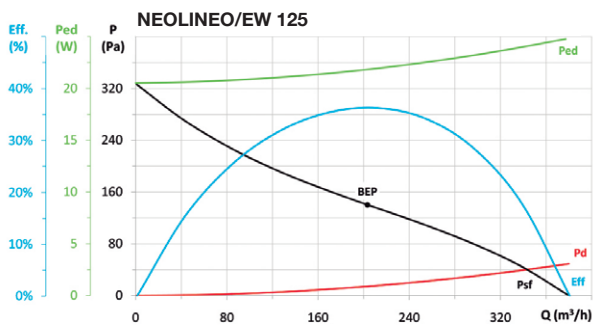

MC	EC	SR	Cc	$\eta_a$ (%)*	N	[kW]	[m³/h]	[Pa]	[rpm]	VSD
A	S	-	-	-	-	0,022	203	140	2370	INTEGRATED

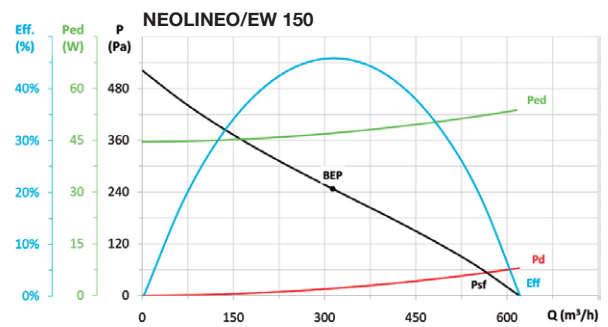

MC	EC	SR	Cc	$\eta_a$ (%)*	N	[kW]	[m³/h]	[Pa]	[rpm]	VSD
A	S	-	-	-	-	0,047	313	247	2560	INTEGRATED



**Erp. Characteristic curves and ErP data**

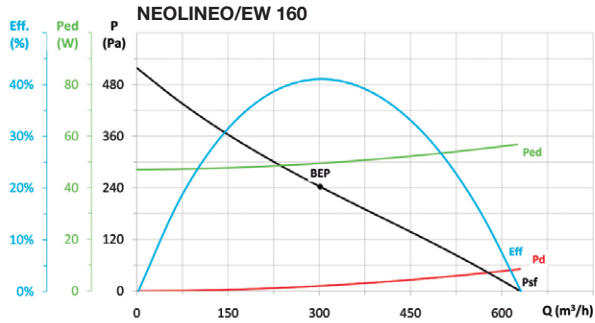

MC	EC	SR	Cc	$\eta_e$ (%)*	N	[kW]	[m³/h]	[Pa]	[rpm]	VSD
A	S	-	-	-	-	0,049	301	242	2620	INTEGRATED

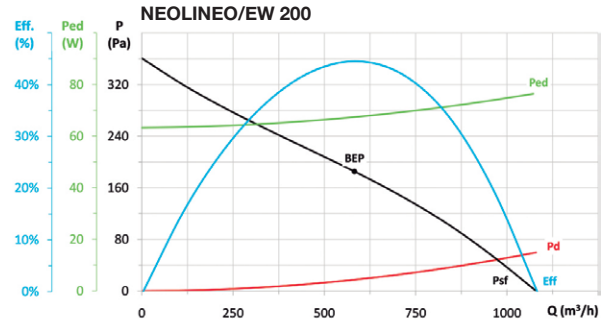

MC	EC	SR	Cc	$\eta_e$ (%)*	N	[kW]	[m³/h]	[Pa]	[rpm]	VSD
A	S	-	-	-	-	0,067	582	185	3120	INTEGRATED

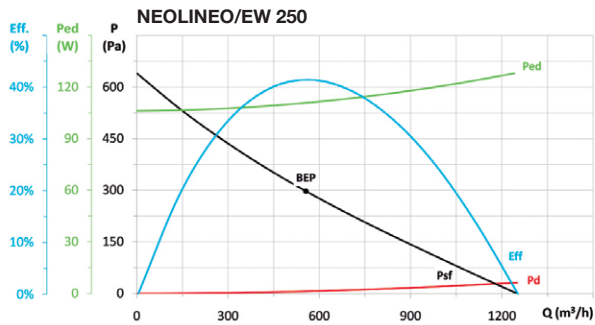

MC	EC	SR	Cc	$\eta_e$ (%)*	N	[kW]	[m³/h]	[Pa]	[rpm]	VSD
A	S	-	-	-	-	0,111	556	297	3010	INTEGRATED