

**CARATTERISTICHE:**

Diffusori multidirezionali a 4 vie con parte centrale coordinata.

**COSTRUZIONE:**

Alluminio verniciato RAL 9010.

**IMPIEGO:**

A controsoffitto modulare  
Altezza di installazione  
2,5-3,1 m.

**FISSAGGIO:**

Fissaggio a controsoffitto.

**CHARACTERISTICS:**

Multidirection diffuser with 4 ways with matched central panel.

**CONSTRUCTION:**

Aluminium painted RAL 9010.







**UTILIZATION:**

For modular false-ceiling installation.  
Installation height: 2,5-3,1m.

**FIXING:**

Fixing on false-ceiling.

**PREZZI - PRICES**

								Serranda per plenum Damper for plenum
BxH	AQC	A	D	PDZ1	PDZ11	PDZ2	PDZ12	
mm	€	mm	mm	€	€	€	€	€
AQC 600x600 1F		352	197					
AQC 600x600 2F		276	197					
AQC 600x600 3F		202	247					
AQC 600x600 4F		127	247					

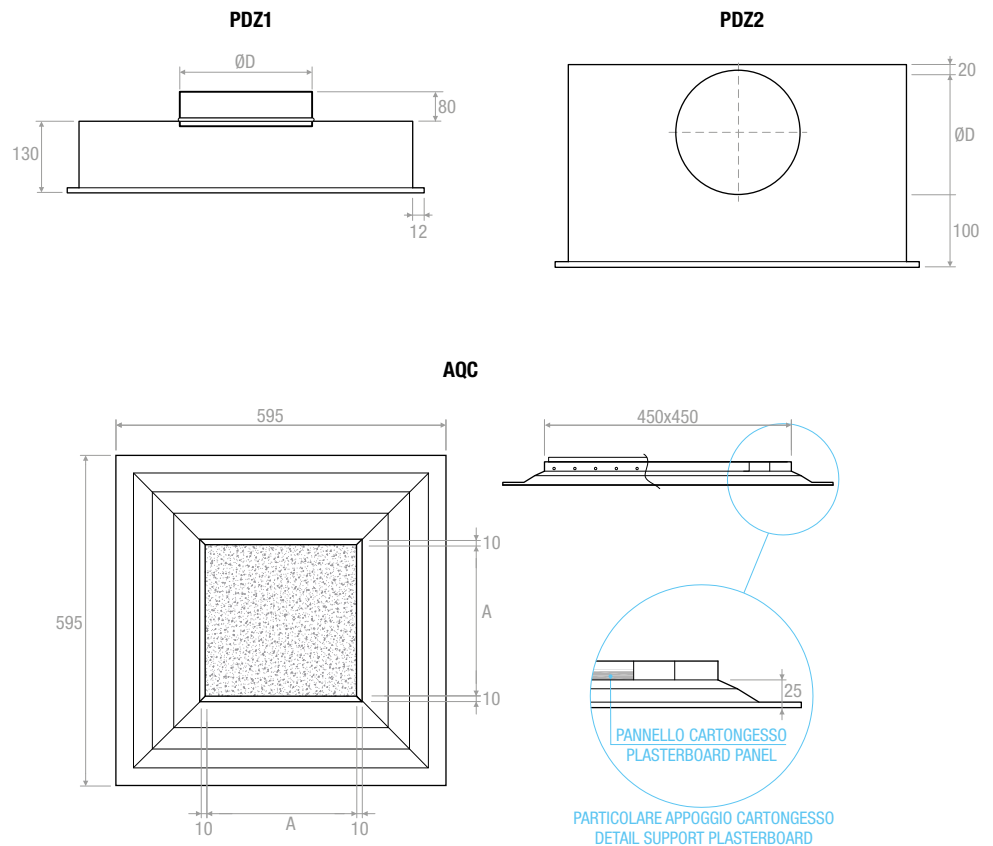
**DISEGNI - DRAWINGS**

NOTA: Parte centrale non fornita  
NOTE: Central part not supplied

## DIAGRAMMA SCELTA RAPIDA - QUICK SELECTION DIAGRAM

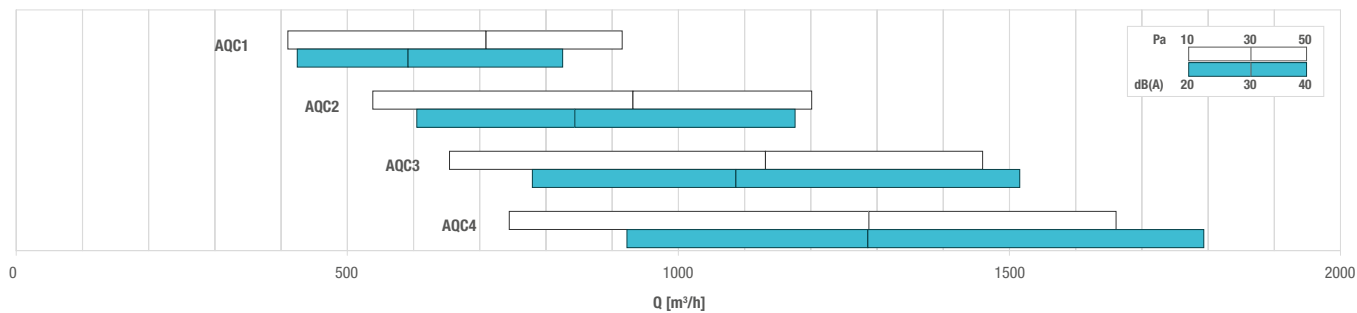

## TABELLA DI SELEZIONE - SELECTION TABLE

Modello - Model	$A_x$ [m <sup>2</sup> ]	No. Vie N. way	Q [m <sup>3</sup> /h]		$L_{WA}$ [dB(A)]		$X_{(0,25)}$ [m]		$Dp_t$ [Pa]	
			min	max	min	max	min	max	min	max
<b>AQC 600x600 1F</b>	0,0438	4	410	920	< 20	43	1,26	6,29	10	50
<b>AQC 600x600 2F</b>	0,0542	4	540	1200	< 20	41	1,22	6,10	10	50
<b>AQC 600x600 3F</b>	0,0631	4	650	1460	< 20	39	1,19	5,97	10	50
<b>AQC 600x600 4F</b>	0,0698	4	740	1660	< 20	38	1,18	5,88	10	50