

**CARATTERISTICHE:**

Diffusori lineari a feritoie con deflettore a goccia.

COSTRUZIONE:

Alluminio anodizzato estruso, deflettore nero RAL 9005 in polipropilene (bianco RAL 9016 su richiesta DLN/DW).

IMPIEGO:

A soffitto, in mandata e ripresa.
Altezza di installazione:
2,5-3,1 m.

FISSAGGIO:

- Mediante viti frontali.
- Con staffa interna mobile.
- Con molle all'interno del plenum.

ACCESSORI:

Plenum di raccordo in acciaio zincato con isolamento.

CHARACTERISTICS:

Linear slot diffusers with drop profile deflector.

CONSTRUCTION:

Anodized extruded aluminium, RAL 9005 black deflector in polypropylene (white RAL 9003 on request).

UTILIZATION:

For ceiling installation and for air intake and delivery.
Installation height: 2,5-3,1 m.









FIXING:

- By frontal screws.
- By inner mounting mobile bracket.
- By springs inside the plenum.

ACCESSORIES:

Galvanized steel connecting plenum with insulation.

PREZZI - PRICES

									
FERITOIE SLOTS	LUNGHEZZA LENGHT	DLN10	DLN20	DLN30	DLN40	DLN50	PDL	PDLI	DLN90
N.	mm*	€	€	€	€	€	€	€	€
1	800								
	1000								
	1500								
	2000								
2	800								
	1000								
	1500								
	2000								
3	800								
	1000								
	1500								
	2000								
4	800								
	1000								
	1500								
	2000								

*N.B.: le lunghezze riportate sono da intendere passaggio aria - The lengths are actual neck sizes

VERNICIATURA - PAINTING:

Colori RAL 9010 - 9016: + 15% - Color RAL 9010 - 9016: + 15%
Altri colori: prezzi a richiesta - Different colors: prices on request

MODELLI - MODELS:

DLN10: Diffusore standard (1) - Standard diffuser (without sliding control damper and deflector) (1)

DLN20: Diffusore con deflettore (1) + (2) - Diffuser with deflector (1) + (2)

DLN30: Diffusore con serranda a scorrimento (1) + (3) - Diffuser with sliding control damper (1) + (3)

DLN40: Diffusore con deflettore e serranda a scorrimento (1) + (2) + (3) - Diffuser with sliding control damper and deflector (1) + (2) + (3)

DLN50: Diffusore con deflettore, serranda a scorrimento e distributore forato (1) + (2) + (3) + (4) - Diffuser with sliding control damper, deflector and perforated distributor (1) + (2) + (3) + (4)

DISEGNI - DRAWINGS

DIAGRAMMA SCELTA RAPIDA - QUICK SELECTION DIAGRAM



TABELLA DI SELEZIONE - SELECTION TABLE

Modello - Model	A _v [m²]	Q [m³/h]		L _{wa} [dB(A)]		X _(0,25) [m]		Dp _t * [Pa]	
		min	max	min	max	min	max	min	max
DLN1 1000	0,01061	120	280	31	50	3,6	8,6	10	50
DLN2 1000	0,02073	240	550	30	49	5,0	11,8	10	50
DLN3 1000	0,03085	350	820	29	48	5,9	14,1	10	50
DLN4 1000	0,04097	470	1080	29	47	6,8	16,0	10	50
DLN5 1000	0,05109	580	1350	28	47	7,5	17,7	10	50
DLN6 1000	0,06121	700	1620	28	47	8,2	19,3	10	50
DLN7 1000	0,07133	810	1890	28	46	8,7	20,7	10	50
DLN8 1000	0,08145	930	2160	27	46	9,3	22,0	10	50

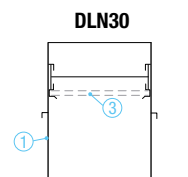
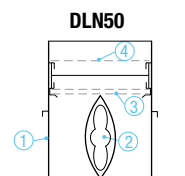
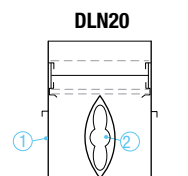
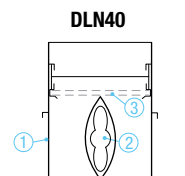
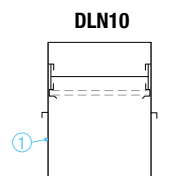
*Senza equalizzatore e serranda completamente aperta - Without equalizer and calibration damper completely open

**DLNR**

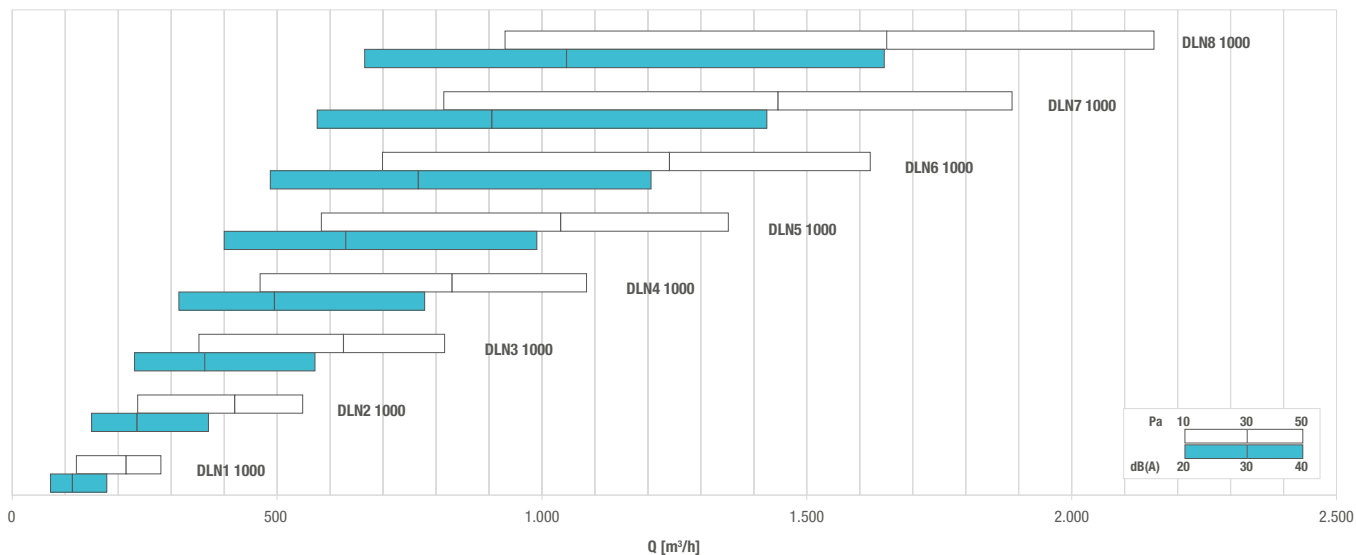
Diffusore lineare con rondella esterna di regolazione
Massima lunghezza 1500 mm

Prezzo aumento 15%

Slot diffuser with external adjustable washer
Maximum length 1500 mm

Price increase 15%



MISURE - MEASURES

N. feritoie N. slots	Lunghezza mm Length mm	Ø collarino est. N. collarini Ø spigot N. spitos	A mm	B mm	C mm	S mm	Z mm	NR. CVL Cavalletti Mounting brackets	NR. CM Molle - Spring
1	800	98-1	40	50	77	54	66	2	2
	1000	98-1						2	2
	1500	98-2						2	2
	2000	98-3						2	3
2	800	148-1	78	89	115	93	105	2	4
	1000	148-2						2	4
	1500	148-3						2	4
	2000	148-4						2	6
3	800	198-1	117	128	155	132	144	2	4
	1000	198-2						2	4
	1500	198-3						2	6
	2000	198-4						3	6
4	800	198-1	155	165	191	169	181	2	4
	1000	198-2						2	4
	1500	198-3						2	6
	2000	198-4						3	6
5	800	248-1	192	202	229	206	218	2	4
	1000	248-1						2	4
	1500	248-2						2	6
	2000	248-2						3	8
6	800	248-1	230	240	267	244	256	2	4
	1000	248-2						2	4
	1500	248-2						2	6
	2000	248-3						3	8
7	800	248-1	266	276	303	280	292	3	6
	1000	248-2						3	6
	1500	248-3						3	8
	2000	248-4						3	8
8	800	248-1	303	313	340	317	329	3	6
	1000	248-2						3	6
	1500	248-3						3	8
	2000	248-4						3	8

DISEGNI - DRAWINGS

DLN50 1 feritoia - slot

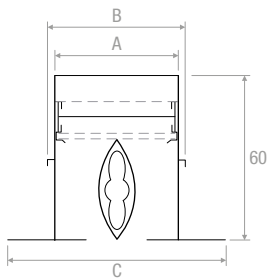

DLN250 2 feritoie - slots

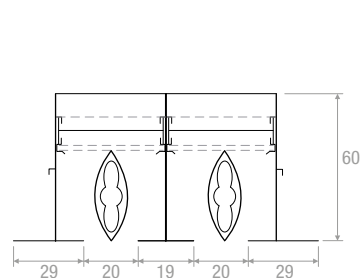

STRANDARD

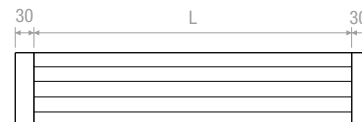
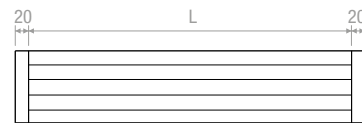
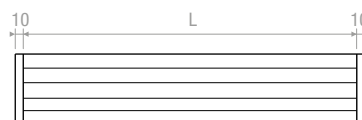
OPZIONE TESTATA 20 mm
OPTION ENDCAPS 20 mmOPZIONE TESTATA 10 mm
OPTION ENDCAPS 10 mm

DISEGNI - DRAWINGS

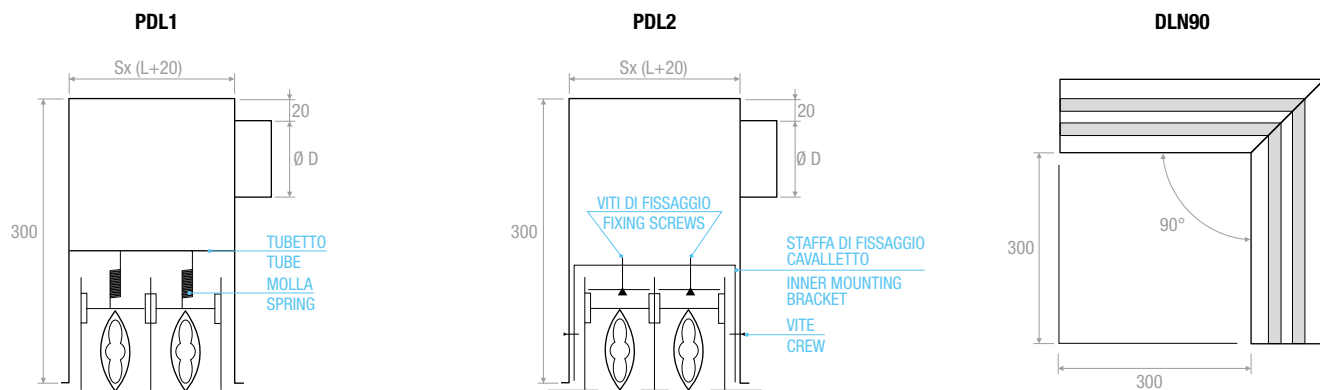

Fissaggio al plenum con staffe CVL cavalletti
Fixing to the plenum by inner mounting brackets CVL

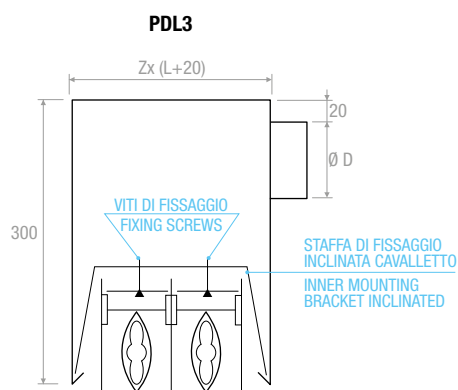

Fissaggio al plenum con staffe inclinate CVL cavalletti
Fixing to the plenum by inner mounting brackets inclined CVL

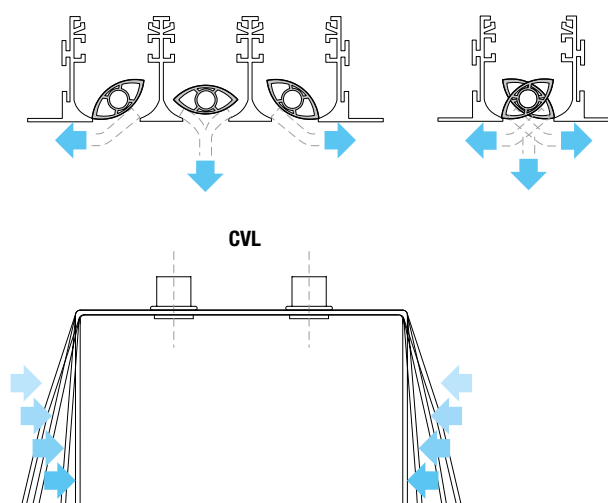

Modifica configurazione CVL da PDL 3 a PDL 2 con pressione delle dita
Configuration change CVL to PDL 3 to PDL 2 with finger pressure

SOLUZIONE DI CONTINUITÀ - CONTINUITY SOLUTION

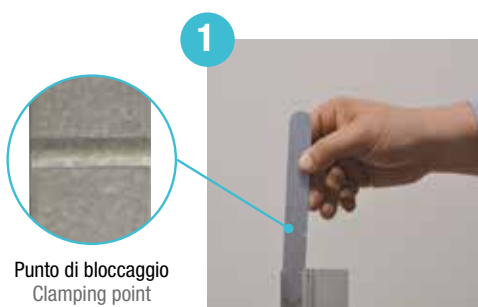

1
Inserire la staffa nel profilo nel senso indicato.
Insert the bracket into the profile in the direction indicated.

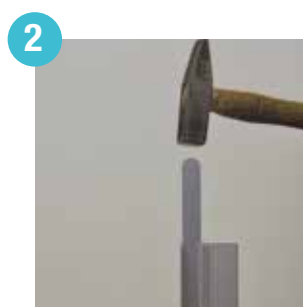

2
Inserire la staffa sino a far penetrare di 10/15 mm il punto di bloccaggio.
Insert the bracket to penetrate up to 10/15 mm the clamping point.



3
Unire i 2 elementi.
Combine the 2 parts.

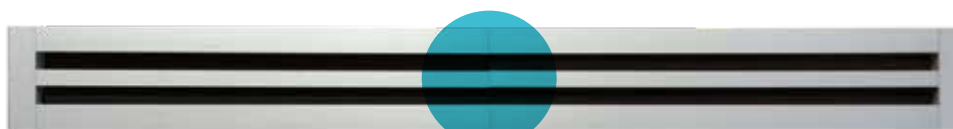

Punto di giunzione
Connection point



SCHEMA MONTAGGIO DIFFUSORE DLF SU PLENUM PDL 1
DLF DIFFUSER PLENUM PDL1 ASSEMBLY DIAGRAM

- 1) Agganciare la molla al tubetto di fissaggio posto all'interno del plenum.
Hook the spring to the mounting tube placed inside the plenum.
- 2) Avvicinare il diffusore al plenum, a mezzo del gancio estendere la molla ed agganciarla al perno autobloccante posto sul diffusore in modo da bloccare il modo unitario la struttura.
Bringing the diffuser to the plenum, by means of the hook to extend the spring and hook it to the self-locking pin on the diffuser so block the way unitary structure.
- 3) Assicurarsi che il fissaggio sia sicuro.
Ensure sure that the attachment is safe.

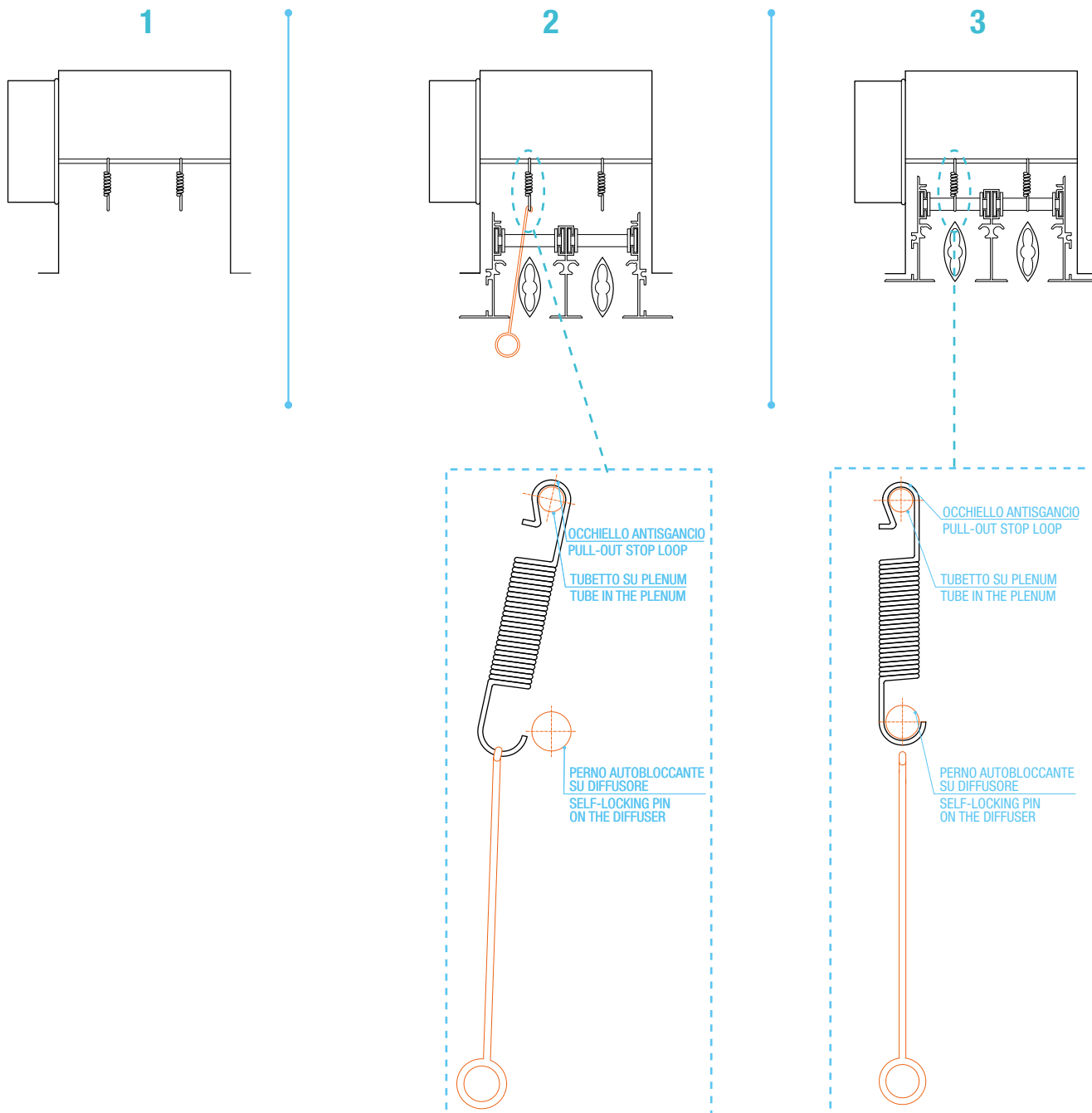

ACCESSORI - ACCESSORIES

		€
CVL 1-4 Feritoie - 1-4 Slots		
CVL 5-8 Feritoie - 5-8 Slots		
CM Molla - Spring		
CG Gancio - Hook		
CC Kit Continuità (2 pezzi) Kit continuity (2 pieces)		

